



Rainbow Waves

Featuring Zuma by Tula Pink

This beautiful quilt is both paper pieced and traditionally pieced to create these beautiful waves of color motion. Zuma is the perfect collection to team with this project.

Collection:	Zuma by Tula Pink
Technique:	Piecing, Paper Piecing, Quilting
Skill Level:	Advanced
Crafting Time:	Longer Term*
Finished Size:	80" x 96" (203.20cm x 243.84cm)

*Crafting time based on Advanced skill level

Project designed by Stacey Day

Tech edited by Linda Turner Griepentrog and Kathryn Patterson

Fabric Requirements

DESIGN	COLOR	ARTICLE CODE	YARDAGE
(A) Sea Stallion	Aqua Marine	PWTP119.AQUAM	3/8 yard (34.29cm)
(B) Sea Stallion	Glow Fish	PWTP119.GLOWF	3/8 yard (34.29cm)
(C) Sea Stallion	Sea Glass	PWTP119.SEAGL	2/3 yard (60.96cm)
(D) Sea Bloom	Aqua Marine	PWTP120.AQUAM	1/4 yard (22.86cm)
(E) Sea Bloom	Glow Fish	PWTP120.GLOWF	1/4 yard (22.86cm)
(F) Sea Bloom	Sea Glass	PWTP120.SEAGL	3/4 yard (68.58cm)
(G) Sea Shells	Aqua Marine	PWTP121.AQUAM	2 1/2 yards (2.29m)
(H) Sea Shells	Glow Fish	PWTP121.GLOWF	1/4 yard (22.86cm)
(I) Sea Shells	Sea Glass	PWTP121.SEAGL	1/2 yard (45.72cm)
(J) White Caps	Aqua Marine	PWTP122.AQUAM	3/8 yard (34.29cm)
(K) White Caps	Glow Fish	PWTP122.GLOWF	1/2 yard (45.72cm)
(L) White Caps	Sea Glass	PWTP122.SEAGL	5/8 yard (57.15cm)
(M) Stingray	Aqua Marine	PWTP123.AQUAM	1/2 yard (45.72cm)
(N) Stingray	Glow Fish	PWTP123.GLOWF	3/8 yard (34.29cm)
(O) Stingray	Sea Glass	PWTP123.SEAGL	3/4 yard (68.58cm)
(P) High Tide	Aqua Marine	PWTP124.AQUAM	1/2 yard (45.72cm)
(Q) High Tide	Glow Fish	PWTP124.GLOWF	1/4 yard (22.86cm)
(R) High Tide	Sea Glass	PWTP124.SEAGL	1/2 yard (45.72cm)
(S) Glitter Litter	Aqua Marine	PWTP125.AQUAM	3/8 yard (34.29cm)
(T) Glitter Litter	Glow Fish	PWTP125.GLOWF	2 1/2 yards (2.29m)
(U) Glitter Litter	Sea Glass	PWTP125.SEAGL	2/3 yard (60.96cm)
(V) Tower 7	Aqua Marine	PWTP126.AQUAM	3/8 yard (34.29cm)
(W) Tower 7	Glow Fish	PWTP126.GLOWF	1/2 yard (45.72cm)
(X) Tower 7	Sea Glass	PWTP126.SEAGL	3/8 yard (34.29cm)
(Y) Tent Stripe	Begonia	PWTP069.BEGON	1/2 yard (45.72cm)*

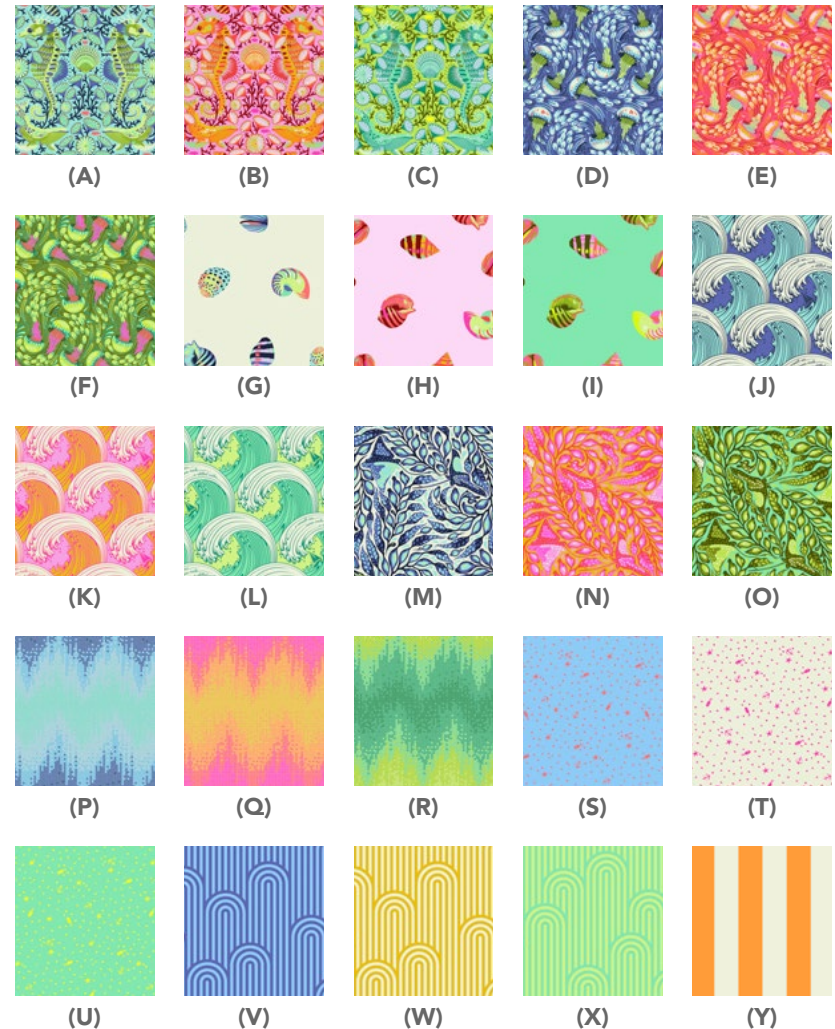

Fabric Requirements

DESIGN	COLOR	ARTICLE CODE	YARDAGE
(Z) Tent Stripe	Petunia	PWTP069.PETUN	½ yard (45.72cm)*
(AA) Pom Pom	Marigold	PWTP118.MARIG	¾ yard (34.29cm)
(BB) Pom Pom	Poppy	PWTP118.POPPY	¼ yard (22.86cm)
(CC) Designer Essentials Solids	Aegean	CSFSESS.AEGEA	⅝ yard (57.15cm)
(DD) Designer Essentials Solids	Cajun	CSFSESS.CAJUN	¼ yard (11.43cm)
(EE) Designer Essentials Solids	Cornflower	CSFSESS.CORNF	¼ yard (22.86cm)
(FF) Designer Essentials Solids	Diva	CSFSESS.DIVAX	¼ yard (11.43cm)
(GG) Designer Essentials Solids	Iris	CSFSESS.IRISX	¼ yard (22.86cm)
(HH) Designer Essentials Solids	Julep	CSFSESS.JULEP	⅝ yard (57.15cm)
(II) Designer Essentials Solids	Mojito	CSFSESS.MOJIT	⅝ yard (57.15cm)
(JJ) Designer Essentials Solids	Sapphire	CSFSESS.SAPPH	¼ yard (22.86cm)

* includes binding

Backing (Purchased Separately)

44" (111.76cm) wide

Sea Bloom Sea Glass PWTP120.SEAGL 7½ yards (6.70m)

OR

108" (274.32cm) wide

FreeFall Sky QBTP001.8SKYXX 2½ yards (2.29m)

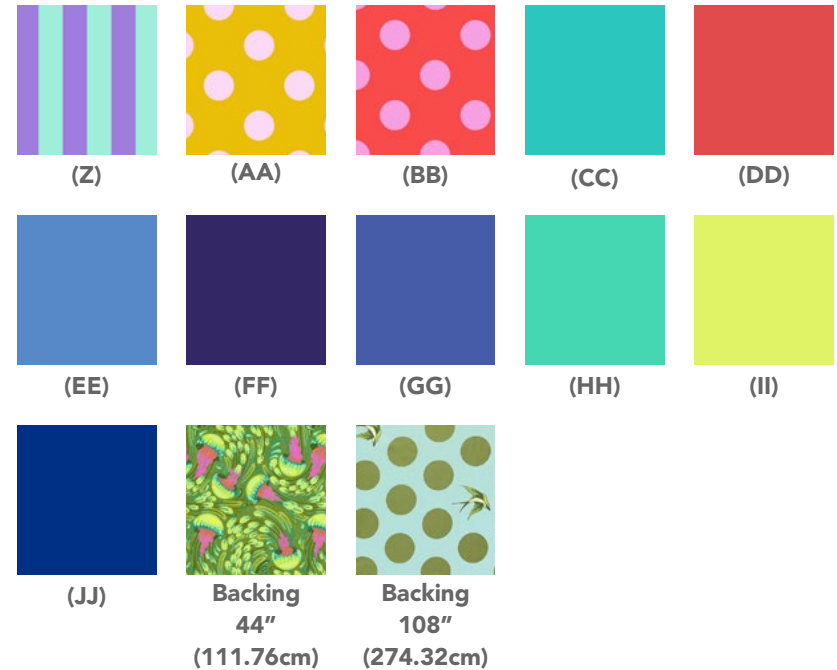

Additional Requirements

- 88" x 104" (223.52cm x 264.16cm) batting
- 100% cotton thread in colors to match
- Foundation piecing paper

Preparation

Make (60) copies each of the C and D Unit Foundations on pages 15 and 16.

Cutting

WOF = Width of Fabric

Tip: Blocks are constructed as Units. As pieces are cut stack in Unit piles and organize by color way. You will have some leftover pieces to use in another project.

Fabrics G and T, cut from each:

(4) $5\frac{3}{4}$ " x WOF (14.61cm x WOF); sub-cut
(45) $2\frac{7}{8}$ " x $5\frac{3}{4}$ " (7.30cm x 14.61cm), stack right side up and cut once diagonally from top left to bottom right into (90) triangles, (60) for C Unit and (30) for D Unit

(4) $5\frac{3}{4}$ " x WOF (14.61cm x WOF); sub-cut
(45) $2\frac{7}{8}$ " x $5\frac{3}{4}$ " (7.30cm x 14.61cm), stack right side up and cut once diagonally from top right to bottom left into (90) triangles, (30) for C Unit and (60) for D Unit

(3) $3\frac{3}{4}$ " x WOF (9.53cm x WOF); sub-cut
(30) $3\frac{3}{4}$ " (9.53cm) squares, cut once diagonally into (60) triangles for E Unit

(4) $2\frac{7}{8}$ " x WOF (7.30cm x WOF); sub-cut
(45) $2\frac{7}{8}$ " (7.30cm) squares, cut once diagonally into (90) triangles for A Unit

(2) $2\frac{1}{2}$ " x WOF (6.35cm x WOF); sub-cut
(30) $2\frac{1}{2}$ " (6.35cm) squares for A Unit

(4) $2\frac{3}{8}$ " x WOF (6.03cm x WOF); sub-cut
(60) $2\frac{3}{8}$ " (6.03cm) squares, cut once diagonally into (120) triangles for B Unit

Fabrics DD and FF, cut from each:

(1) $2\frac{7}{8}$ " x WOF (7.30cm x WOF); sub-cut
(1) $2\frac{7}{8}$ " x $5\frac{3}{4}$ " (7.30cm x 14.61cm), right side up, cut once diagonally from top right to bottom left into (2) triangles for C Unit;
(1) $2\frac{7}{8}$ " x $5\frac{3}{4}$ " (7.30cm x 14.61cm), right side up, cut once diagonally from top left to bottom right into (2) triangles for D Unit; and
(2) $2\frac{3}{8}$ " (6.03cm) squares, cut once diagonally into (4) triangles for A Unit

Fabrics BB and JJ, cut from each:

(1) $4\frac{7}{8}$ " x WOF (12.38cm x WOF); sub-cut
(1) $4\frac{7}{8}$ " x $8\frac{3}{4}$ " (12.38cm x 22.23cm) rectangle for C Unit;
(1) $4\frac{7}{8}$ " x $8\frac{3}{4}$ " (12.38cm x 22.23cm) rectangle for D Unit;
(1) $4\frac{7}{8}$ " (12.38cm) square, cut once diagonally into (2) triangles for E Unit; and
(2) $2\frac{7}{8}$ " (7.30cm) squares, cut once diagonally into (4) triangles, (1) for A Unit and (2) for B Unit

Fabrics E and GG, cut from each:

(1) $4\frac{7}{8}$ " x WOF (12.38cm x WOF); sub-cut
(1) $4\frac{7}{8}$ " (12.38cm) square, cut once diagonally into (2) triangles for E Unit;
(1) $4\frac{1}{2}$ " (11.43cm) square for E Unit;
(2) $2\frac{7}{8}$ " (7.30cm) squares, cut once diagonally into (4) triangles for B Unit; and
(2) $2\frac{1}{2}$ " (6.35cm) squares for B Unit

Fabrics D and Q, cut from each:

(1) $4\frac{7}{8}$ " x WOF (12.38cm x WOF); sub-cut
(1) $4\frac{7}{8}$ " x $8\frac{3}{4}$ " (12.38cm x 22.23cm) rectangle for C Unit;
(1) $4\frac{7}{8}$ " x $8\frac{3}{4}$ " (12.38cm x 22.23cm) rectangle for D Unit and
(1) $4\frac{7}{8}$ " (12.38cm) square, cut once diagonally into (2) triangles for E Unit

(1) $2\frac{7}{8}$ " x WOF (7.30cm x WOF); sub-cut
(1) $2\frac{7}{8}$ " x $5\frac{3}{4}$ " (7.30cm x 14.61cm), right side up, cut once diagonally from top right to bottom left into (2) triangles for C Unit;
(1) $2\frac{7}{8}$ " x $5\frac{3}{4}$ " (7.30cm x 14.61cm), right side up, cut once diagonally from top left to bottom right into (2) triangles for D Unit;
(2) $2\frac{7}{8}$ " (7.30cm) squares, cut once diagonally into (4) triangles, (1) for A Unit and (2) for B Unit; and
(4) $2\frac{3}{8}$ " (6.03cm) squares, cut once diagonally into (8) triangles for A Unit

Fabrics B and V, cut from each:

(1) $4\frac{7}{8}$ " x WOF (12.38cm x WOF); sub-cut
(2) $4\frac{7}{8}$ " x $8\frac{3}{4}$ " (12.38cm x 22.23cm) rectangles for C Unit;
(2) $4\frac{7}{8}$ " x $8\frac{3}{4}$ " (12.38cm x 22.23cm) rectangles for D Unit; and
(1) $4\frac{7}{8}$ " (12.38cm) square, cut once diagonally into (2) triangles for E unit
(1) $2\frac{7}{8}$ " x WOF (7.30cm x WOF); sub-cut
(1) $2\frac{7}{8}$ " x $5\frac{3}{4}$ " (7.30cm x 14.61cm), right side up, cut once diagonally from top right to bottom left into (2) triangles for C Unit;
(1) $2\frac{7}{8}$ " x $5\frac{3}{4}$ " (7.30cm x 14.61cm), right side up, cut once diagonally from top left to bottom right into (2) triangles for D Unit
(3) $2\frac{7}{8}$ " (7.30cm) squares, cut once diagonally into (6) triangles, (2) for A Unit and (4) for B Unit; and
(2) $2\frac{3}{8}$ " (6.03cm) squares, cut once diagonally into (4) triangles for A Unit

Fabrics H and EE, cut from each:

- (1) $4\frac{7}{8}$ " x WOF (12.38cm x WOF); sub-cut
- (2) $4\frac{7}{8}$ " (12.38cm) squares, cut once diagonally into (4) triangles for E Unit;
- (2) $4\frac{1}{2}$ " (11.43cm) squares for E Unit;
- (4) $2\frac{3}{8}$ " (7.30cm) squares, cut once diagonally into (8) triangles for B Unit; and
- (4) $2\frac{1}{2}$ " (6.35cm) squares for B Unit

Fabrics J and N, cut from each:

- (1) $4\frac{7}{8}$ " x WOF (12.38cm x WOF); sub-cut
- (2) $4\frac{7}{8}$ " x $8\frac{3}{4}$ " (12.38cm x 22.23cm) rectangles for C Unit;
- (2) $4\frac{7}{8}$ " x $8\frac{3}{4}$ " (12.38cm x 22.23cm) rectangles for D Unit; and
- (1) $4\frac{7}{8}$ " (12.38cm) square, cut once diagonally into (2) triangles for E Unit
- (1) $2\frac{7}{8}$ " x WOF (7.30cm x WOF); sub-cut
- (2) $2\frac{7}{8}$ " x $5\frac{3}{4}$ " (7.30cm x 14.61cm), right side up, cut once diagonally from top right to bottom left into (4) triangles for C Unit;
- (2) $2\frac{7}{8}$ " x $5\frac{3}{4}$ " (7.30cm x 14.61cm), right side up, cut once diagonally from top left to bottom right into (4) triangles for D Unit; and
- (3) $2\frac{7}{8}$ " (7.30cm) squares, cut once diagonally into (6) triangles, (2) for A Unit and (4) for B Unit;
- (1) $2\frac{3}{8}$ " x WOF (6.03cm x WOF); sub-cut
- (6) $2\frac{3}{8}$ " (6.03cm) squares, cut once diagonally into (12) triangles for A Unit

Fabrics K and M, cut from each:

- (2) $4\frac{7}{8}$ " x WOF (12.38cm x WOF); sub-cut
- (3) $4\frac{7}{8}$ " x $8\frac{3}{4}$ " (12.38cm x 22.23cm) rectangles for C Unit;
- (3) $4\frac{7}{8}$ " x $8\frac{3}{4}$ " (12.38cm x 22.23cm) rectangles for D Unit; and
- (2) $4\frac{7}{8}$ " (12.38cm) squares, cut once diagonally into (4) triangles for E Unit

- (1) $2\frac{7}{8}$ " x WOF (7.30cm x WOF); sub-cut
- (1) $2\frac{7}{8}$ " x $5\frac{3}{4}$ " (7.30cm x 14.61cm), right side up, cut once diagonally from top right to bottom left into (2) triangles for C Unit;
- (1) $2\frac{7}{8}$ " x $5\frac{3}{4}$ " (7.30cm x 14.61cm), right side up, cut once diagonally from top left to bottom right into (2) triangles for D Unit;
- (5) $2\frac{7}{8}$ " (7.30cm) squares, cut once diagonally into (10) triangles, (3) for A Unit and (6) for B Unit; and
- (4) $2\frac{3}{8}$ " (6.03cm) squares, cut once diagonally into (8) triangles for A Unit

Fabrics S and AA, cut from each:

- (1) $4\frac{7}{8}$ " x WOF (12.38cm x WOF); sub-cut
- (3) $4\frac{7}{8}$ " (12.38cm) squares, cut once diagonally into (6) triangles for E Unit; and
- (3) $4\frac{1}{2}$ " (11.43cm) squares for E Unit
- (1) $2\frac{7}{8}$ " x WOF (7.30cm x WOF); sub-cut
- (6) $2\frac{7}{8}$ " (7.30cm) squares, cut once diagonally into (12) triangles for B Unit; and
- (6) $2\frac{1}{2}$ " (6.35cm) squares for B Unit

Fabrics P and W, cut from each:

- (2) $4\frac{7}{8}$ " x WOF (12.38cm x WOF); sub-cut
- (3) $4\frac{7}{8}$ " x $8\frac{3}{4}$ " (12.38cm x 22.23cm) rectangles for C Unit;
- (3) $4\frac{7}{8}$ " x $8\frac{3}{4}$ " (12.38cm x 22.23cm) rectangles for D Unit; and
- (2) $4\frac{7}{8}$ " (12.38cm) squares, cut once diagonally into (4) triangles for E Unit
- (1) $2\frac{7}{8}$ " x WOF (7.30cm x WOF); sub-cut
- (2) $2\frac{7}{8}$ " x $5\frac{3}{4}$ " (7.30cm x 14.61cm), right side up, cut once diagonally from top right to bottom left into (4) triangles for C Unit;
- (2) $2\frac{7}{8}$ " x $5\frac{3}{4}$ " (7.30cm x 14.61cm), right side up, cut once diagonally from top left to bottom right into (4) triangles for D Unit;
- (5) $2\frac{7}{8}$ " (7.30cm) squares, cut once diagonally into (10) triangles, (3) for A Unit and (6) for B Unit;

- (1) $2\frac{3}{8}$ " x WOF (6.03cm x WOF); sub-cut
- (8) $2\frac{3}{8}$ " (6.03cm) squares, cut once diagonally into (16) triangles for A Unit

Fabrics CC and II, cut from each:

- (2) $4\frac{7}{8}$ " x WOF (12.38cm x WOF); sub-cut
- (4) $4\frac{7}{8}$ " x $8\frac{3}{4}$ " (12.38cm x 22.23cm) rectangles for C Unit;
- (4) $4\frac{7}{8}$ " x $8\frac{3}{4}$ " (12.38cm x 22.23cm) rectangles for D Unit; and
- (2) $4\frac{7}{8}$ " (12.38cm) squares, cut once diagonally into (4) triangles for E Unit
- (2) $2\frac{7}{8}$ " x WOF (7.30cm x WOF); sub-cut
- (2) $2\frac{7}{8}$ " x $5\frac{3}{4}$ " (7.30cm x 14.61cm), right side up, cut once diagonally from top right to bottom left into (4) triangles for C Unit;
- (2) $2\frac{7}{8}$ " x $5\frac{3}{4}$ " (7.30cm x 14.61cm), right side up, cut once diagonally from top left to bottom right into (4) triangles for D Unit;
- (6) $2\frac{7}{8}$ " (7.30cm) squares, cut once diagonally into (12) triangles, (4) for A Unit and (8) for B Unit; and
- (6) $2\frac{3}{8}$ " (6.03cm) squares, cut once diagonally into (12) triangles for A Unit

Fabrics A and X, cut from each:

- (1) $4\frac{7}{8}$ " x WOF (12.38cm x WOF); sub-cut
- (4) $4\frac{7}{8}$ " (12.38cm) squares, cut once diagonally into (8) triangles for E Unit; and
- (4) $4\frac{1}{2}$ " (11.43cm) squares for E Unit
- (1) $2\frac{7}{8}$ " x WOF (7.30cm x WOF); sub-cut
- (8) $2\frac{7}{8}$ " (7.30cm) squares, cut once diagonally into (16) triangles for B Unit
- (1) $2\frac{1}{2}$ " x WOF (6.35cm x WOF); sub-cut
- (8) $2\frac{1}{2}$ " (6.35cm) squares for B Unit

Fabrics L and HH, cut from each:

- (2) 4⁷/₈" x WOF (12.38cm x WOF); sub-cut
 - (4) 4⁷/₈" x 8³/₄" (12.38cm x 22.23cm) rectangles for C Unit;
 - (4) 4⁷/₈" x 8³/₄" (12.38cm x 22.23cm) rectangles for D Unit; and
 - (2) 4⁷/₈" (12.38cm) squares, cut once diagonally into (4) triangles for E Unit
- (2) 2⁷/₈" x WOF (7.30cm x WOF); sub-cut
 - (3) 2⁷/₈" x 5³/₄" (7.30cm x 14.61cm), right side up, cut once diagonally from top right to bottom left into (6) triangles for C Unit;
 - (3) 2⁷/₈" x 5³/₄" (7.30cm x 14.61cm), right side up, cut once diagonally from top left to bottom right into (6) triangles for D Unit;
 - (6) 2⁷/₈" (7.30cm) squares, cut once diagonally into (12) triangles, (4) for A Unit and (8) for B Unit; and
 - (10) 2³/₈" (6.03cm) squares, cut once diagonally into (20) triangles for A Unit

Fabrics C and U, cut from each:

- (3) 4⁷/₈" x WOF (12.38cm x WOF); sub-cut
 - (5) 4⁷/₈" x 8³/₄" (12.38cm x 22.23cm) rectangles for C Unit;
 - (5) 4⁷/₈" x 8³/₄" (12.38cm x 22.23cm) rectangles for D Unit; and
 - (3) 4⁷/₈" (12.38cm) squares, cut once diagonally into (6) triangles for E Unit
- (2) 2⁷/₈" x WOF (7.30cm x WOF); sub-cut
 - (2) 2⁷/₈" x 5³/₄" (7.30cm x 14.61cm), right side up, cut once diagonally from top right to bottom left into (4) triangles for C Unit;
 - (2) 2⁷/₈" x 5³/₄" (7.30cm x 14.61cm), right side up, cut once diagonally from top left to bottom right into (4) triangles for D Unit;
 - (8) 2⁷/₈" (7.30cm) squares, cut once diagonally into (16) triangles, (5) for A Unit and (10) for B Unit; and
 - (8) 2³/₈" (6.03cm) squares, cut once diagonally into (16) triangles for A Unit

Fabrics I and R, cut from each:

- (1) 4⁷/₈" x WOF (12.38cm x WOF); sub-cut
 - (5) 4⁷/₈" (12.38cm) squares, cut once diagonally into (10) triangles for E Unit; and
 - (3) 4¹/₂" (11.43cm) squares for E Unit
- (1) 4¹/₂" x WOF (11.43cm); sub-cut
 - (2) 4¹/₂" (11.43cm) squares for E Unit; and
 - (6) 2¹/₂" (6.35cm) squares for B Unit
- (1) 2⁷/₈" x WOF (7.30cm x WOF); sub-cut
 - (10) 2⁷/₈" (7.30cm) squares, cut once diagonally into (20) triangles for B Unit; and
 - (4) 2¹/₂" (6.35cm) squares for B Unit

Fabrics F and O, cut from each:

- (3) 4⁷/₈" x WOF (12.38cm x WOF); sub-cut
 - (5) 4⁷/₈" x 8³/₄" (12.38cm x 22.23cm) rectangles for C Unit;
 - (5) 4⁷/₈" x 8³/₄" (12.38cm x 22.23cm) rectangles for D Unit; and
 - (3) 4⁷/₈" (12.38cm) squares, cut once diagonally into (6) triangles for E Unit
- (2) 2⁷/₈" x WOF (7.30cm x WOF); sub-cut
 - (3) 2⁷/₈" x 5³/₄" (7.30cm x 14.61cm), right side up, cut once diagonally from top right to bottom left into (6) triangles for C Unit;
 - (3) 2⁷/₈" x 5³/₄" (7.30cm x 14.61cm), right side up, cut once diagonally from top left to bottom right into (6) triangles for D Unit; and
 - (8) 2⁷/₈" (7.30cm) squares, cut once diagonally into (16) triangles, (5) for A Unit and (10) for B Unit;
- (1) 2³/₈" x WOF (6.03cm x WOF); sub-cut
 - (10) 2³/₈" (6.03cm) squares, cut once diagonally into (20) triangles for A Unit

Fabrics Y and Z, cut from each:

Enough 2¹/₄" (5.72cm) bias strips to make 182" (4.62m) of finished binding

Sewing

Note: All seam allowances are 1/4" (.64cm) and pieces are sewn right sides together. Press seams as directed. Blocks are constructed from Units. The Units are labeled with a unit letter and block number. During block construction, units with the same number will be sewn together to make a block, with 10 block types total.

1. **To make an A Unit:** Sew (2) print 2³/₈" (6.03cm) triangles to opposite sides of a background 2⁷/₈" (6.35cm) square. Press seams toward the triangles. Sew a second pair of 2³/₈" (6.03cm) print triangles to the remaining sides and press. Trim and square to 3⁵/₈" (8.41cm).

Note: When trimming leave a 1/4" (.64cm) seam allowance from the sewn triangle points.

Repeat with (3) 2⁷/₈" (7.30cm) background triangles and (1) 2⁷/₈" (7.30cm) print triangle, pressing seams toward the triangles. Trim and square to 4¹/₂" (11.43cm). Following the color pairings and quantities shown, make the A units. Label each A Unit with its block number and set aside (**Fig. 1**) on page 8.

2. **To make a B Unit:** Sew (2) 2³/₈" (6.03cm) background triangles to opposite sides of a 2¹/₂" (6.35cm) print square. Press seams toward the triangles. Sew a second pair of 2³/₈" (6.03cm) background triangles to the remaining sides and press. Trim and square to 3⁵/₈" (8.41cm). Repeat with (4) 2⁷/₈" (7.30cm) print triangles, pressing toward the triangles. Trim and square to 4¹/₂" (11.43cm). Following the color pairings and quantities shown, make the B units. Label each B Unit with its block number and set aside (**Fig. 2**) on page 9.

3. **To make a C Unit:** Center (1) $4\frac{7}{8}$ " x $8\frac{3}{4}$ " (12.38cm x 22.23cm) rectangle over a C Unit foundation, wrong sides together, and pin. With the paper side up fold the paper foundation back, along the line between segments 1 and 2. Trim the fabric showing to $\frac{1}{4}$ " (.64cm). Open the paper and press flat. On the fabric side, place (1) $2\frac{7}{8}$ " x $5\frac{3}{4}$ " (7.30cm x 14.61cm) background triangle, right sides together, along the cut edge. Holding it in place, flip the background fabric right side up and ensure it completely covers segment 2 of the foundation. Unflip and pin in place. With the foundation paper side up, sew along the line between segments 1 and 2. Finger press triangle open. Repeat this process to attach a background triangle over segment 3, then a background and print triangle over the remaining segments. Trim and square to $4\frac{1}{2}$ " x $8\frac{1}{2}$ " (11.43cm x 21.59cm). Following the color pairings and quantities shown, make the C units. Label each C Unit with its block number and set aside (**Fig. 3**) on page 10.
4. **To make a D Unit:** Using the same process as C Unit, sew (3) background and (1) print $2\frac{7}{8}$ " x $5\frac{3}{4}$ " (7.30cm x 14.61cm) triangles around the center $4\frac{7}{8}$ " x $8\frac{3}{4}$ " (12.38cm x 22.23cm) rectangle on a D Unit foundation; trim. Following the color pairings and quantities shown, make the D units. Label each D Unit with its block number and set aside (**Fig. 4**) on page 11.
5. **To make an E Unit:** Sew (2) $3\frac{3}{4}$ " (9.53cm) background triangles to opposite sides of a $4\frac{1}{2}$ " (11.43cm) print square. Press seams toward the triangles. Sew a second pair of $3\frac{3}{4}$ " (9.53cm) background triangles to the remaining sides and press. Trim and square to $6\frac{1}{8}$ " (15.56cm). Repeat with (4) $4\frac{7}{8}$ " (12.38cm) print triangles, pressing toward the triangles. Trim and square to $8\frac{1}{2}$ " (21.59cm). Following the color pairings and quantities shown, make the E units. Label each E Unit with its block number and set aside (**Fig. 5**) on page 12.

6. **To Make a Block:** Lay out the (2) A1 Units, (2) B1 Units, (2) C1 Units, (2) D1 Units, and E1 unit for Block 1 as shown in (**Fig. 6**) on page 13, paying attention to the color placement. Sew the (3) rows of the block, then sew the rows together to complete Block 1. Press the seams open. Trim and square to $16\frac{1}{2}$ " (41.91cm). Following the color pairings and quantities shown, work a Block at a time to make the remaining Blocks, 30 total. Label each Block with its block number and set aside.

Quilt Top Assembly

TIP: Lay out the blocks on a design wall or flat surface before sewing, to make sure the blocks are oriented correctly. The prints will form uninterrupted diagonal lines from bottom left to top right when all the blocks are oriented correctly.

7. Following the **Quilt Layout** diagram on page 14 lay out the blocks in (6) rows of (5) blocks each, paying close attention to the color placement and orientation. Sew the blocks together in each row, matching adjacent seams. Press seams in alternate directions for adjacent rows. Sew the rows together in order, matching adjacent seams, to make the quilt top. Press the seams toward the bottom of the quilt top.

Finishing

8. Layer the backing, batting, and quilt top; baste the layers together and quilt as desired. Trim the batting and backing even with the quilt top.
9. Sew the **Fabric Y** bias binding strips end to end using diagonal seams to make one continuous piece. Sew the **Fabric Z** bias binding strips end to end using diagonal seams to make one continuous piece. Sew the **Fabric Y** and **Z** strips together on one end. Fold in half wrong sides together and press the length.
10. Pin the binding to the quilt top, starting in the top right corner, lining up the seam in the binding with the corner, so that the **Fabric Y** binding is to the top and left side of the quilt and the **Fabric Z** binding is to the right and bottom of the quilt when it is mitered. Continue pinning the binding around the quilt top, mitering the corners, until you reach the bottom left corner. Sew the binding ends together to form a continuous loop that meets at the corner. Finish sewing the binding in place, taking care not to stretch it.
11. Turn the binding to the back of quilt and hand-stitch in place.

Fig. 1

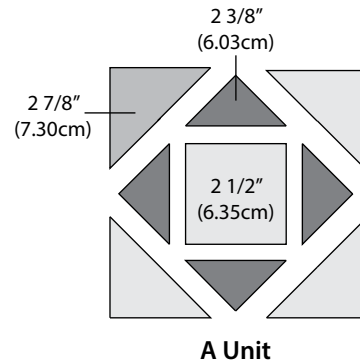

Fabric T Background

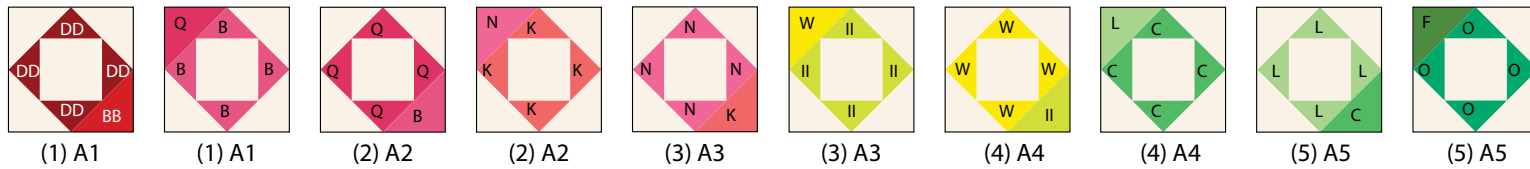

Fabric G Background

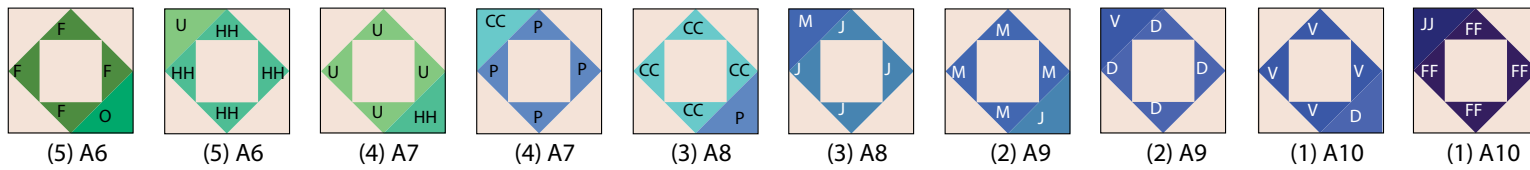
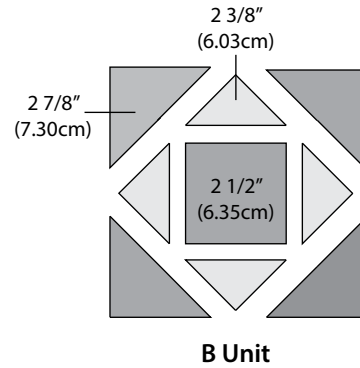
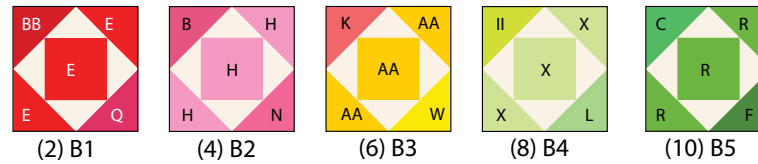

Fig. 2



Fabric T Background



Fabric G Background

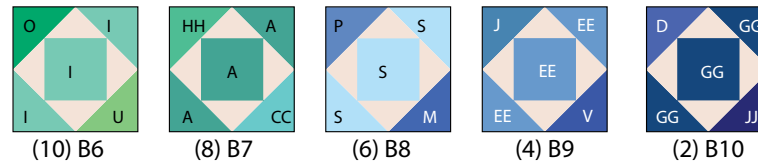
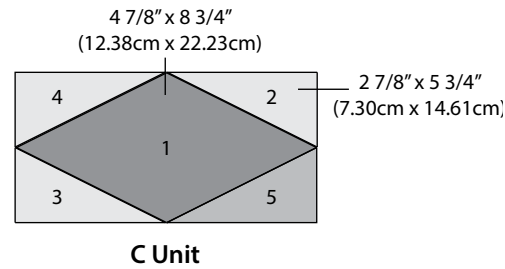
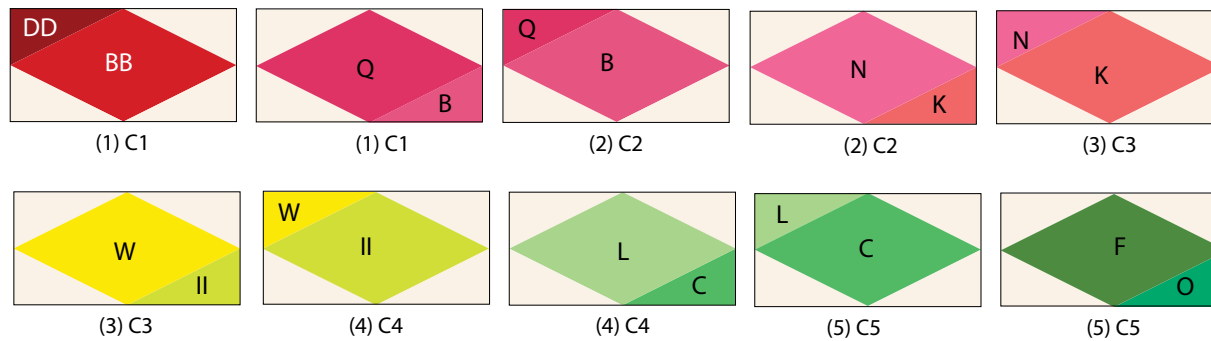

Fig. 3



Fabric T Background



Fabric G Background

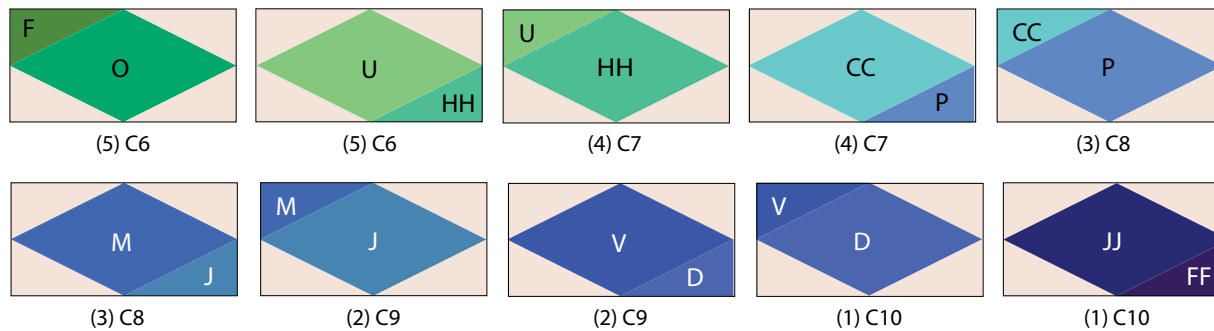
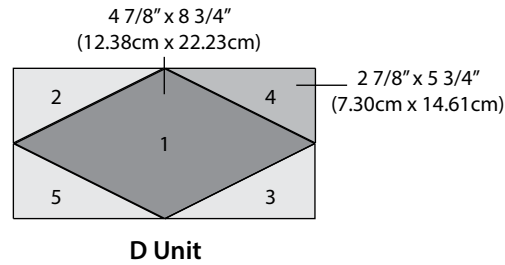
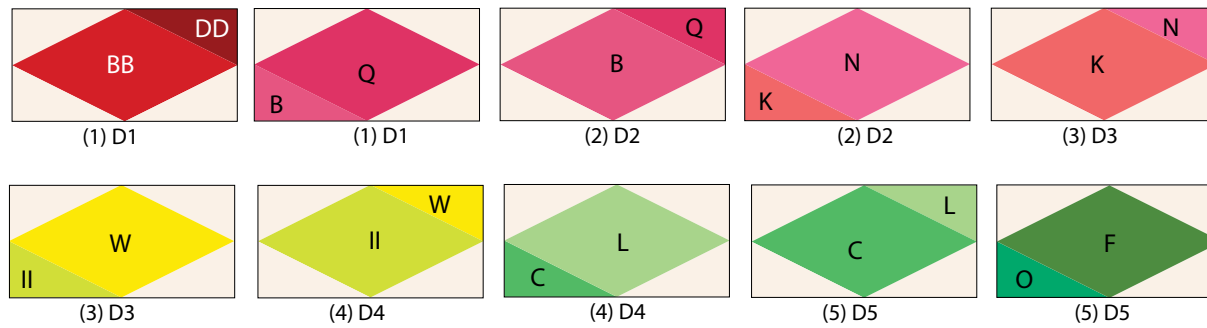

Fig. 4



Fabric T Background



Fabric G Background

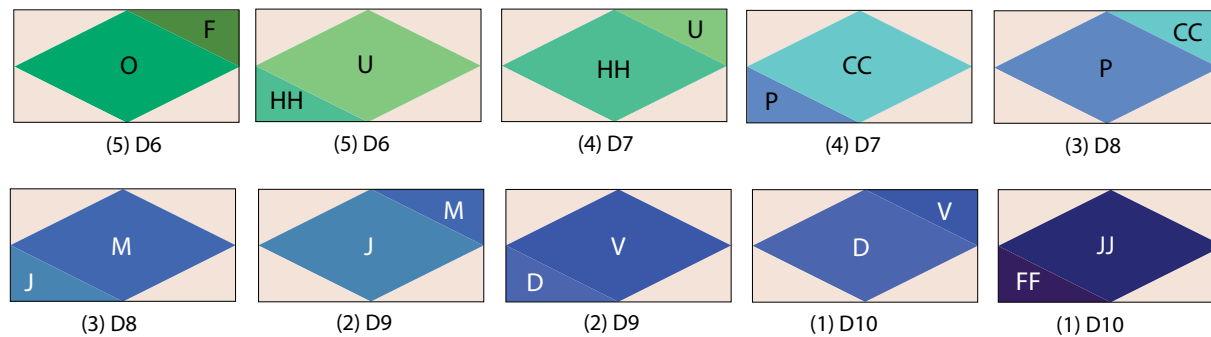
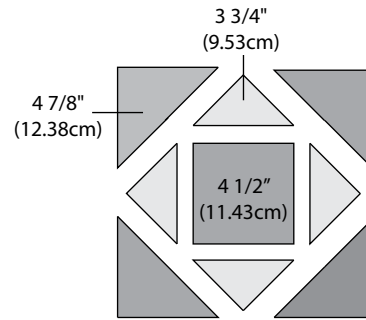
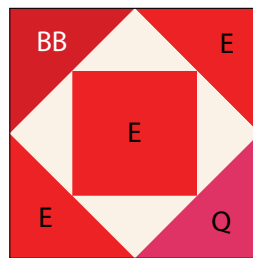

Fig. 5



E Unit

Fabric T Background



(1) E1

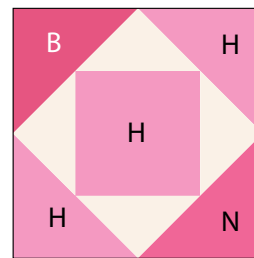

(2) E2

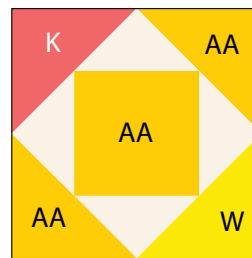

(3) E3

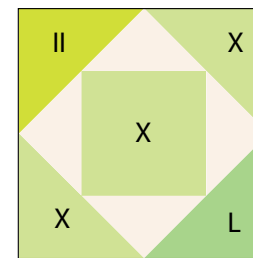

(4) E4

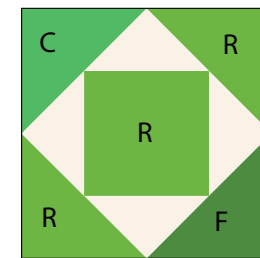

(5) E5

Fabric G Background

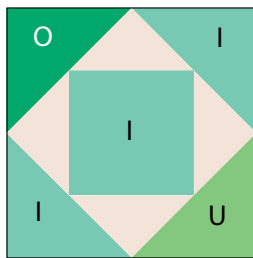

(5) E6

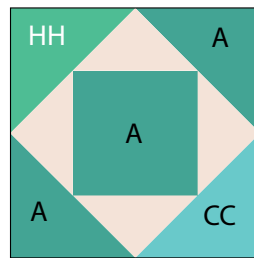

(4) E7

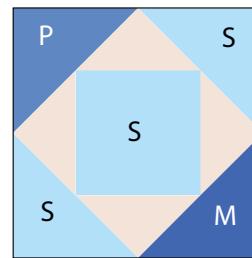

(3) E8

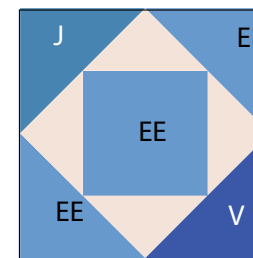

(2) E9

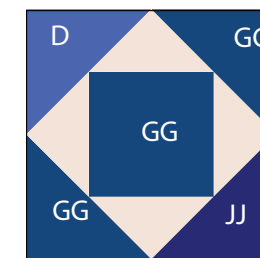

(1) E10

Fig. 6

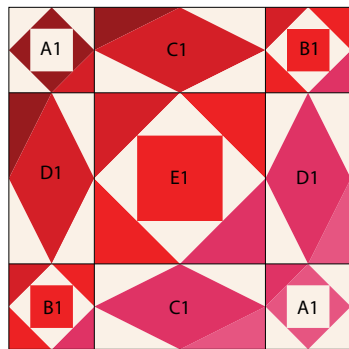
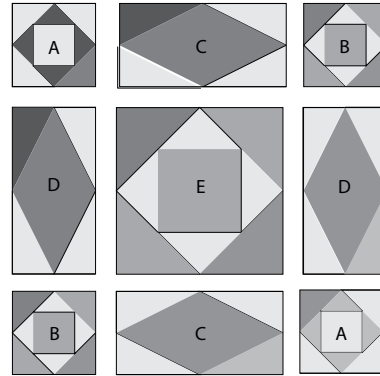

(1) Block 1

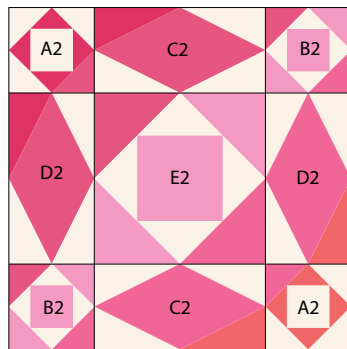

(2) Block 2

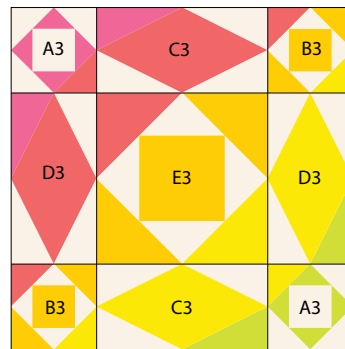

(3) Block 3

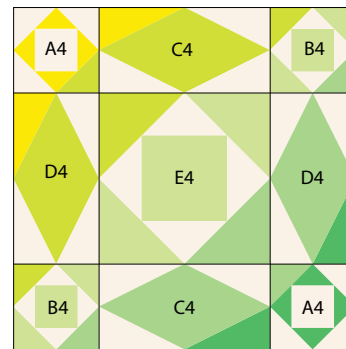

(4) Block 4

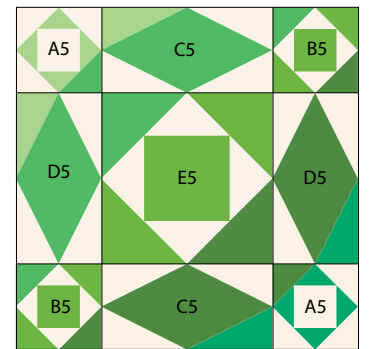

(5) Block 5

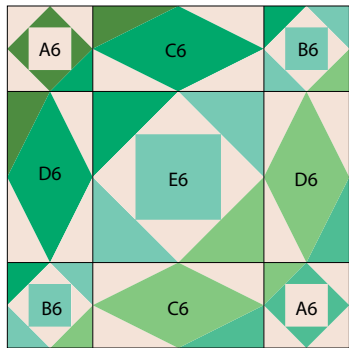

(5) Block 6

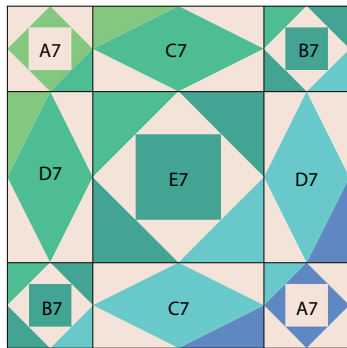

(4) Block 7

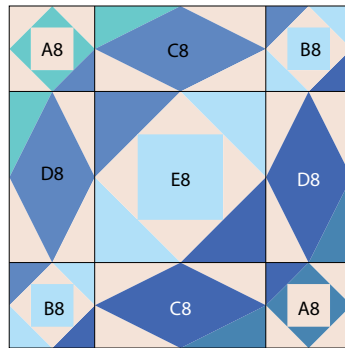

(3) Block 8

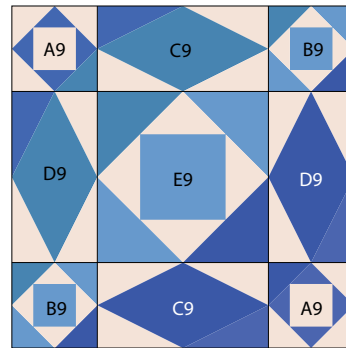

(2) Block 9

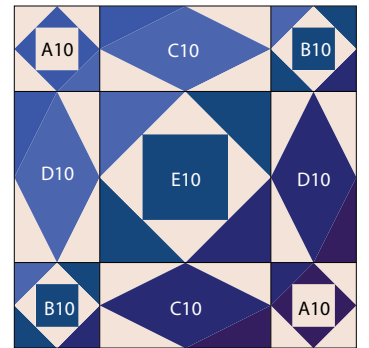

(1) Block 10

Quilt Layout

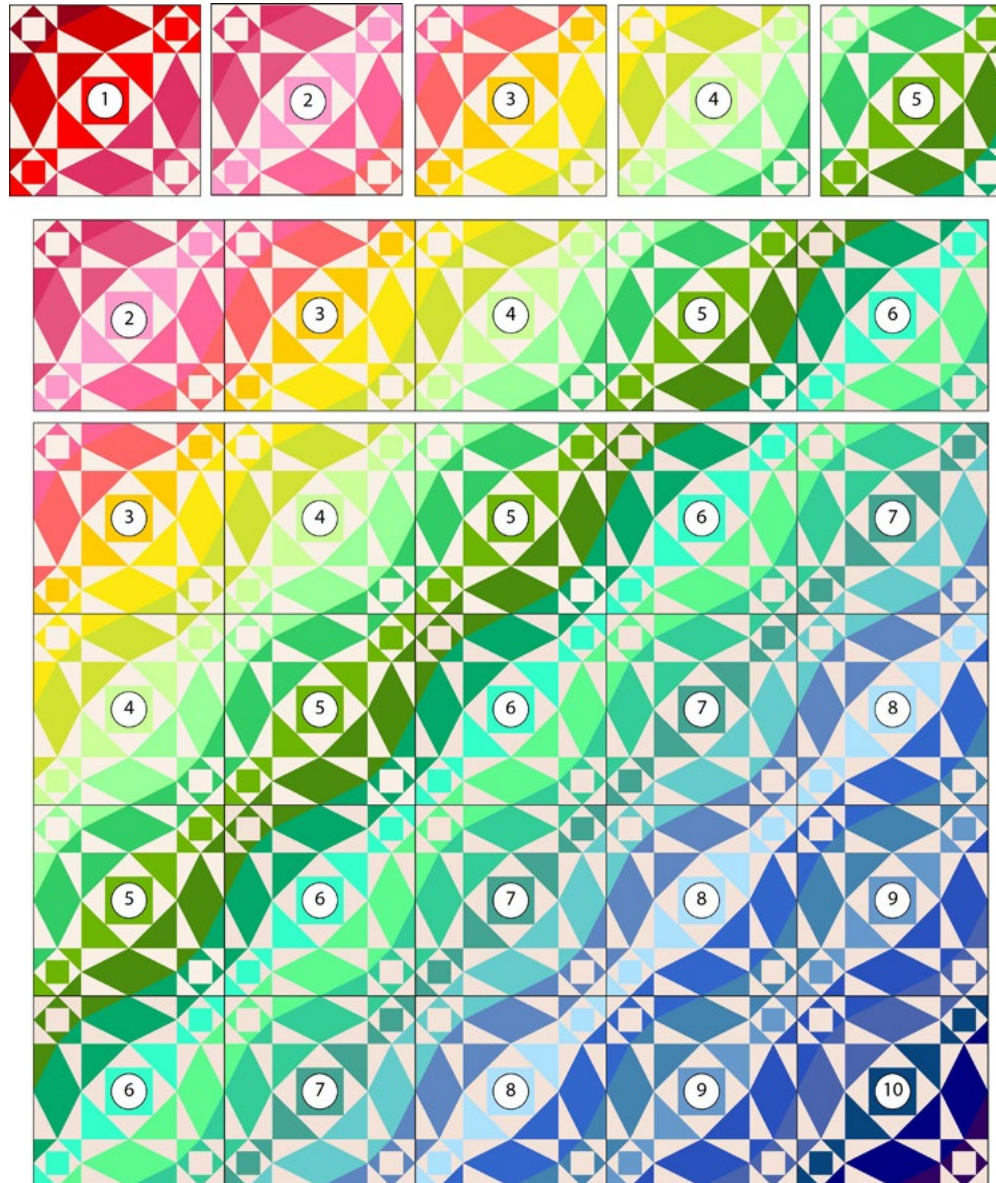

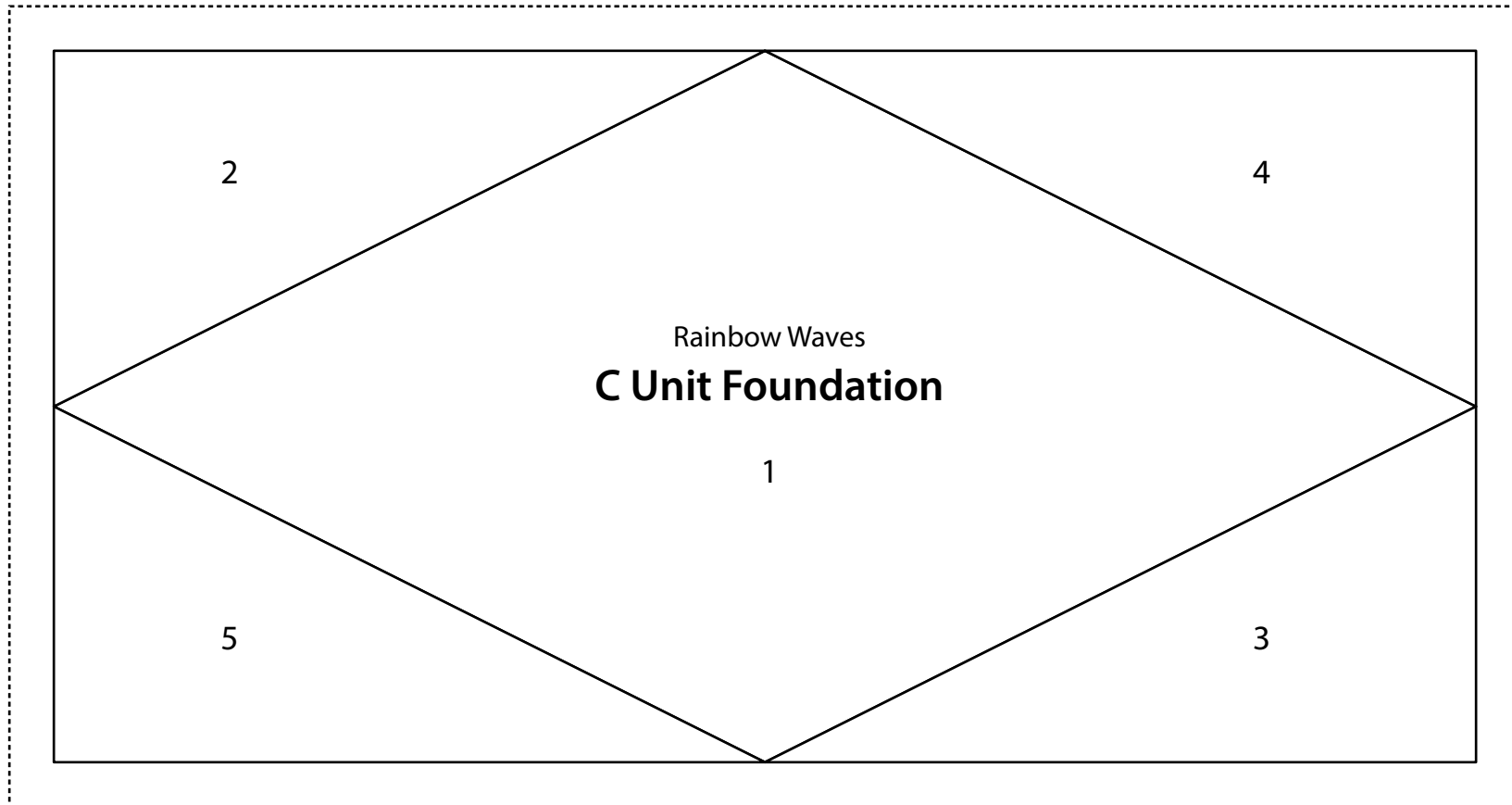

This square should
measure 1" x 1"
(2.54cm x 2.54cm)
when printed.

***** Measure templates before cutting to confirm printing at 100%*****

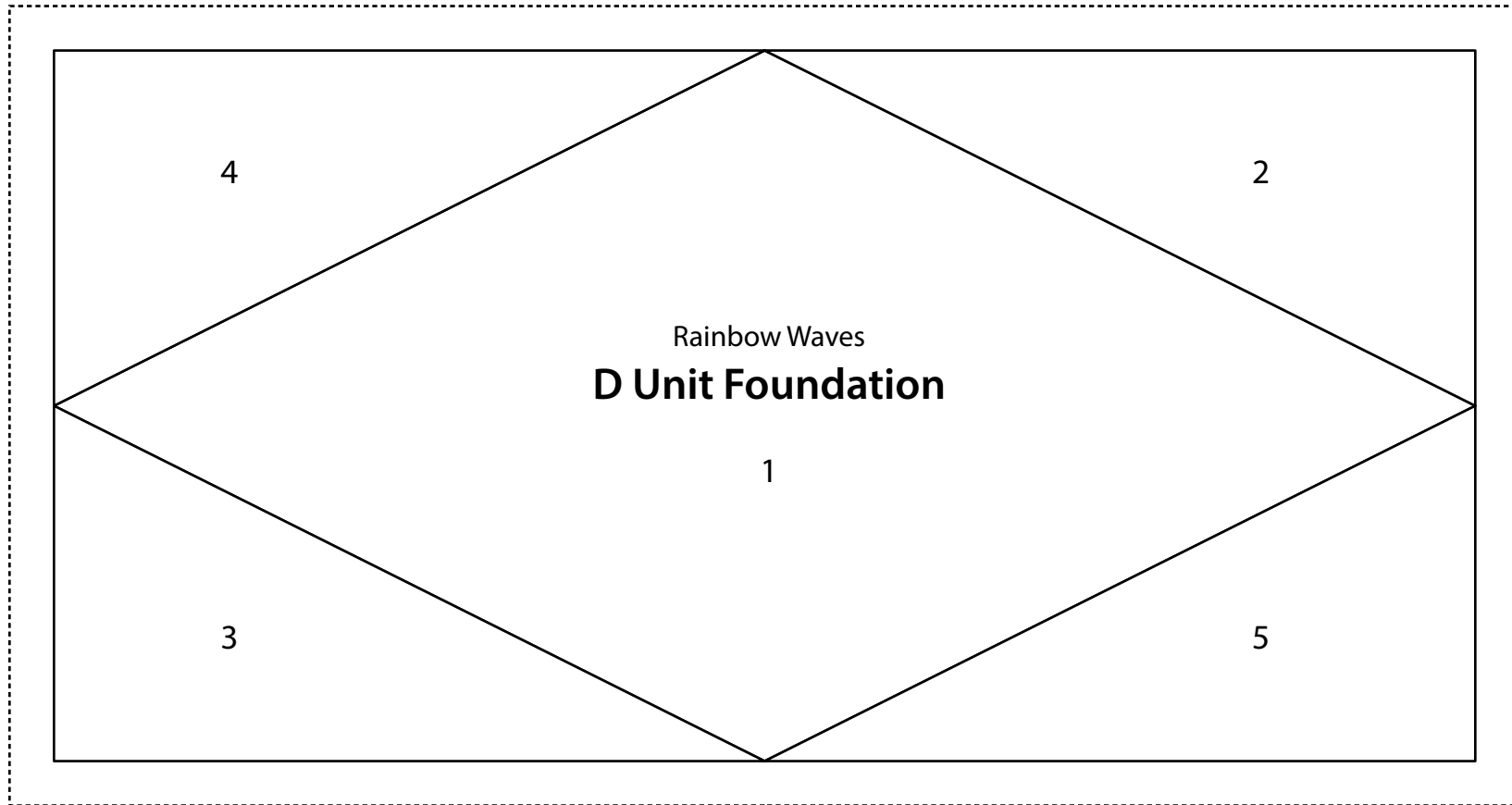

This square should
measure 1" x 1"
(2.54cm x 2.54cm)
when printed.

***** Measure templates before cutting to confirm printing at 100%*****